

Article number: 206153M20KSPFB

Description: E+G spring plungers 615.3-M20-KS-PFB

## Measures

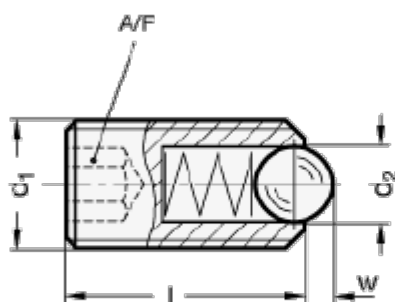

Thread locking **PFB**  
Polyamide patch  
for type **K**



Thread locking **PFB**  
Polyamide patch  
for type **KS**



Thread locking **MVK**  
Micro encapsulation precote  
(for all types)

A/F	= 10
d1	= M20
d2	= 12
l	= 43
Max. spring load in N	= 166
Preload spring pressure in N	= 84
w	= 4.5